

Article number: 2082277M12B

Description: E+G Mini indexing plunger
without rest position, GN 822.6-7-M12-B

Measures

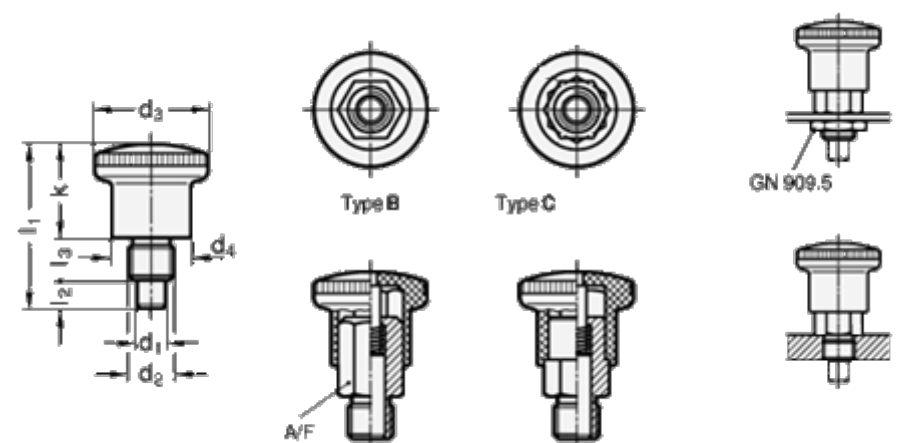

d1 = 7
d2 = M12
d3 = 28
d4 = 20
k = 23.5
l1 = 40.5
l2 = 7
l3 = 10

Spring load initial N = 10